



OFFICE DESIGN IDEAS BOOK FOR:

- OFFICE SUITES
- CONFERENCE ROOM
- CUBICLES
- SEATING: CONFERENCE CHAIRS

PARKEISTMP

11,000 SQ. FT.
RICHMOND, CA



cubicles.com

we're so much more than cubicles

☎ 888-442-8242

2D OVERALL PROPOSED FURNITURE LAYOUT

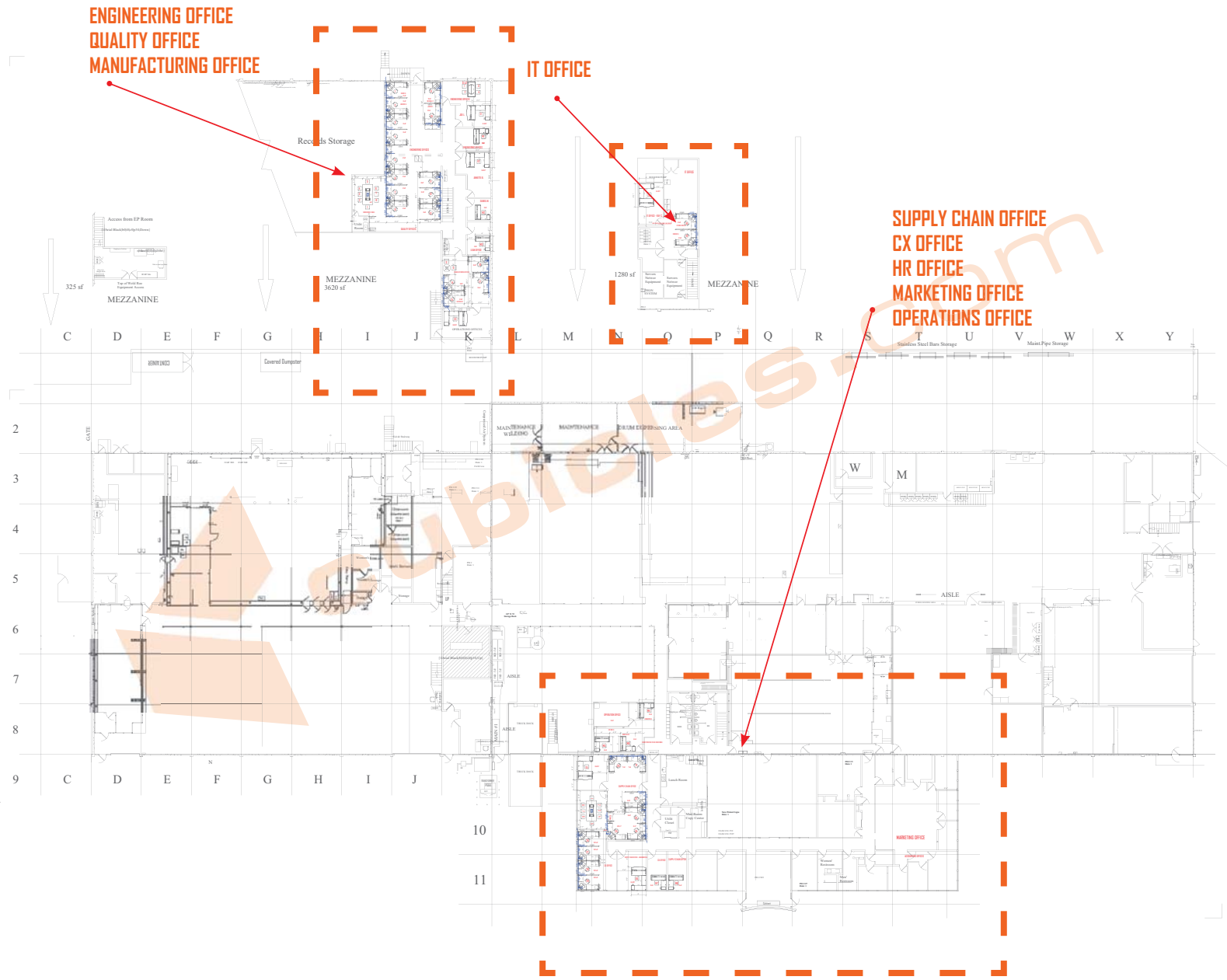

SPD Corporate Office Furniture

2D ENGINEERINGS OFFICES/MANUFACTURING OFFICES

OFFICE SUITES

[3] 6'x8' L-SHAPE DESK W/
MAIN DESK HEIGHT ADJUSTABLE
[1] BOX/BOX/FILE PEDESTAL / EA

[3] 6'x9'6" U-SHAPE DESK W/
MAIN DESK HEIGHT ADJUSTABLE
[1] BOX/BOX/FILE PEDESTAL / EA
[1] FILE /FILE PEDESTAL / EA

STATIONS

[11] 6'x8'x53"H POWERED STATIONS W/
[1] BOX/BOX/FILE PEDESTAL
[1] HEIGHT ADJUSTABLE CORNER
[1] DUPLEX WITH USB

[3] 6'x8'x67"H POWERED STATIONS W/
[1] BOX/BOX/FILE PEDESTAL
[1] HEIGHT ADJUSTABLE CORNER
[1] DUPLEX WITH USB

[3] 8'x6'x53H POWERED STATIONS W/
[1] BOX/BOX/FILE PEDESTAL
[1] HEIGHT ADJUSTABLE CORNER
[1] DUPLEX WITH USB

[1] 6'x3' MEETING TABLE

53"H FABRIC PANEL

53"H FABRIC/GLASS PANEL
-39"H FABRIC
-14"H GLASS

6'x3' MEETING TABLE

U-SHAPE DESK
LATERAL FILE W/TOP

L-SHAPE DESK
DUPLEX/W USB

HEIGHT ADJUSTABLE CORNER

BOX/BOX/FILE PEDESTAL

CONFERENCE TABLE W/
POWER BOX

67"H FABRIC/GLASS PANEL
-53"H FABRIC
-14"H GLASS

STATIONS 9&10

6'x3' MEETING TABLE

U-SHAPE DESK
MAIN DESK: HEIGHT
ADJUSTABLE



NINE

I

J

K

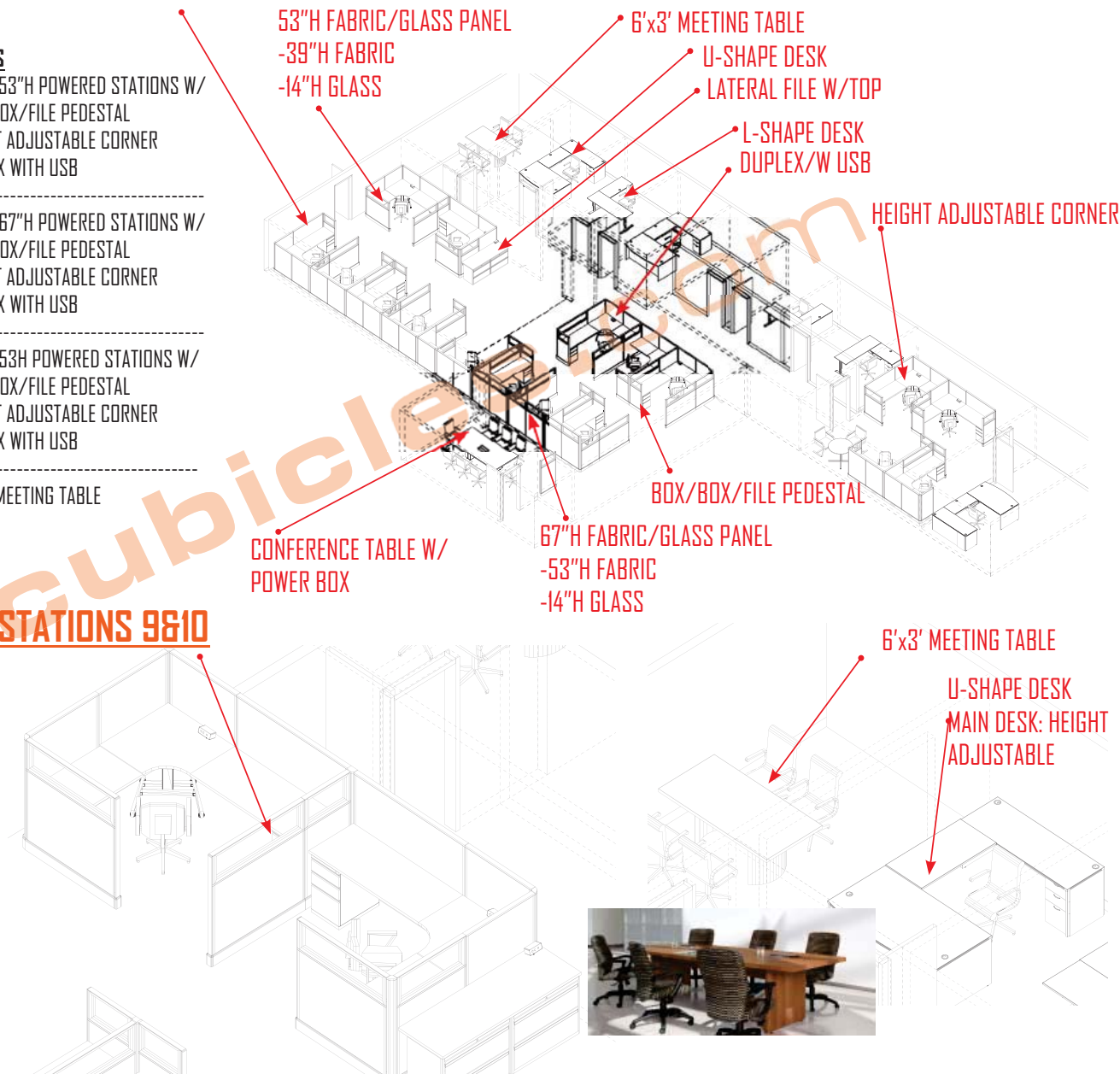

SPD Corporate Office Furniture
2D MEZZANINE (IT OFFICE)

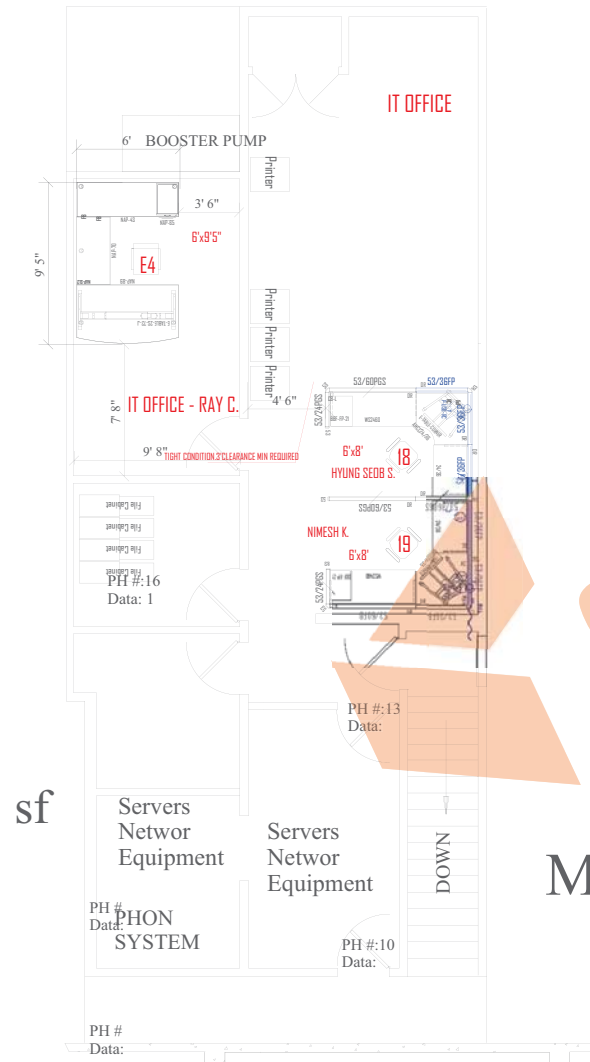

STATIONS 18-21

STATIONS

- [1] 6'x8'x53"H POWERED STATIONS W/
- [1] BOX/BOX/FILE PEDESTAL
- [1] HEIGHT ADJUSTABLE CORNER
- [1] DUPLEX WITH USB
- [1] 8'x6'x53"H POWERED STATIONS W/
- [1] BOX/BOX/FILE PEDESTAL
- [1] HEIGHT ADJUSTABLE CORNER
- [1] DUPLEX WITH USB

OFFICE SUITES

- [1] 6'x9'6" U-SHAPE DESK W/
- MAIN DESK HEIGHT ADJUSTABLE
- [1] BOX/BOX/FILE PEDESTAL / EA
- [1] FILE /FILE PEDESTAL / EA

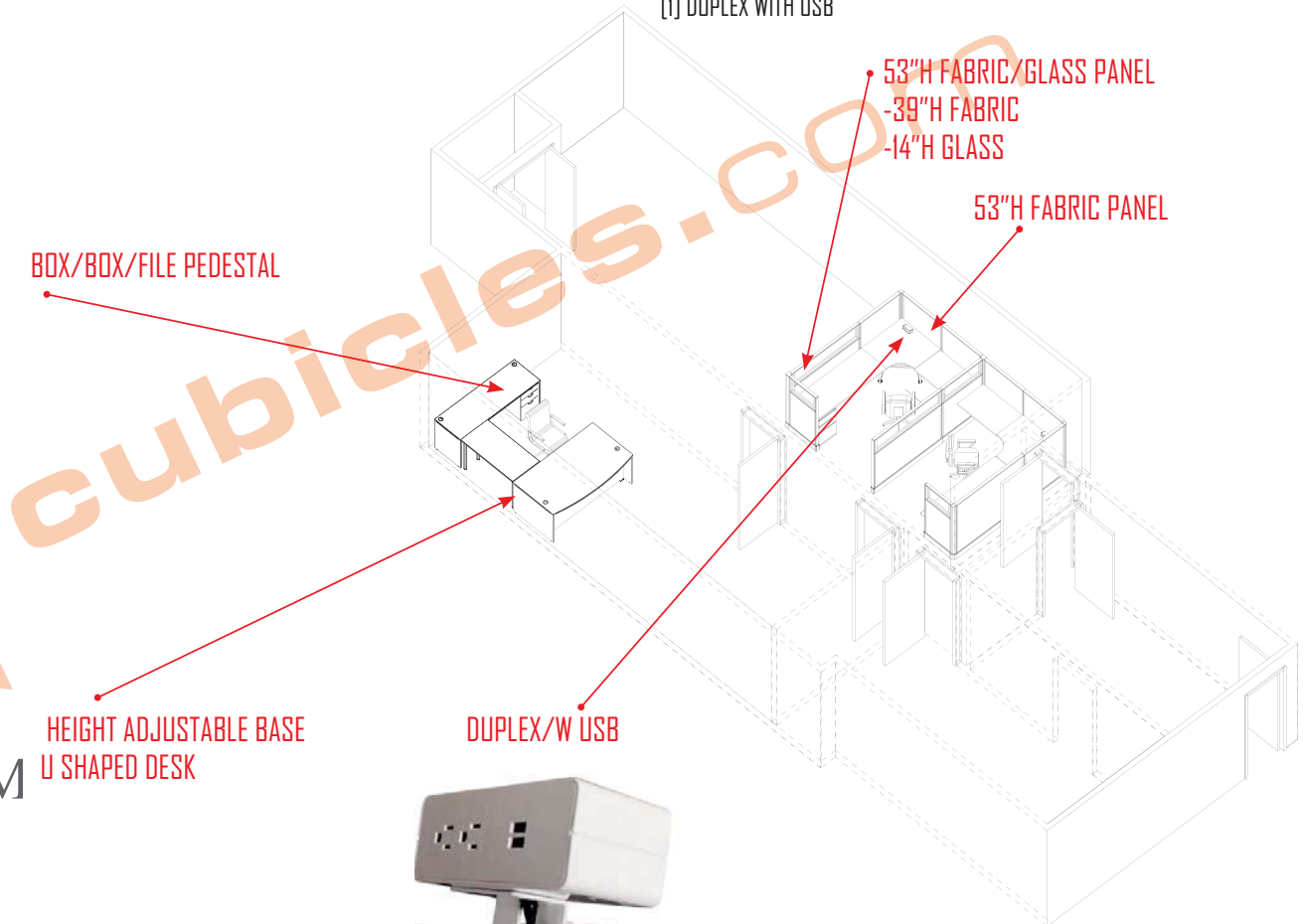

2D
OPERATION OFFICE; SUPPLY CHAIN OFFICE; CX OFFICE; HR OFFICE; ACCOUNTING OFFICE & MARKETING OFFICE
 SPD Corporate Office Furniture



OFFICE SUITES

[5] 6'x6' L-SHAPE DESK W/
 MAIN DESK HEIGHT ADJUSTABLE
 [1] BOX/BOX/FILE PEDESTAL / EA

[2] 6'x9'6" U-SHAPE DESK W/
 MAIN DESK HEIGHT ADJUSTABLE
 [1] BOX/BOX/FILE PEDESTAL / EA
 [1] FILE /FILE PEDESTAL / EA

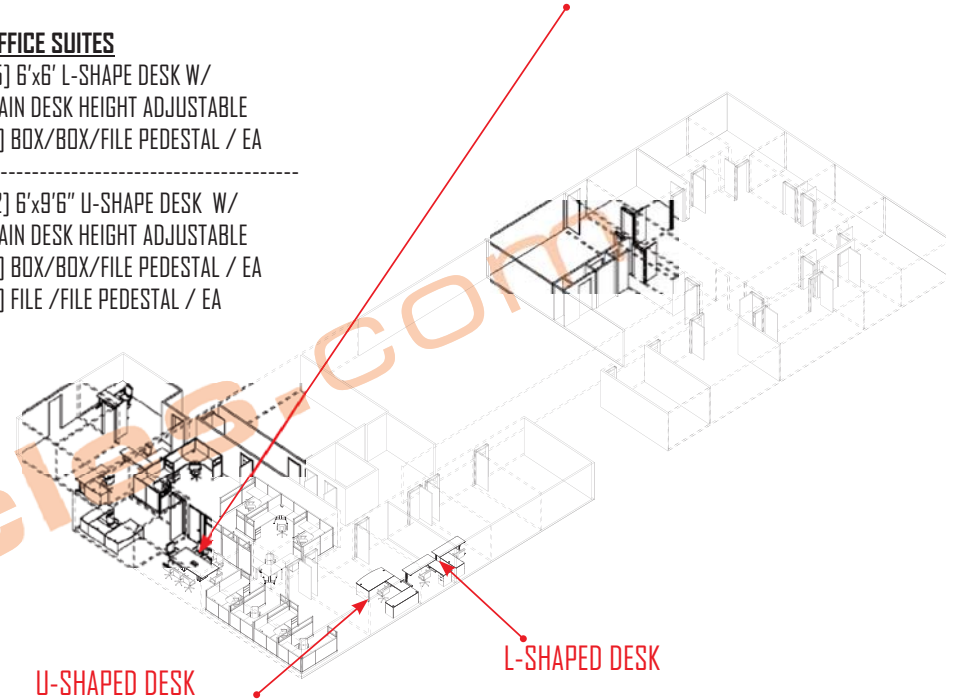

U-SHAPED DESK

L-SHAPED DESK

STATIONS

[2] 7'x6'x53"H POWERED STATIONS

[2] 6'x8'x53"H POWERED STATIONS

[1] 6'x7'x53"H POWERED STATIONS

[1] 6'6"x7' POWERED PRINTER AREA

[4] 5'6"x8'x39"/53"H POWERED STATIONS

ACCESSORY

[1] BOX/BOX/FILE PEDESTAL / EA

[1] HEIGHT ADJUSTABLE CORNER BASE / EA

[1] DUPLEX W/ USB / EA

STATIONS 29-32

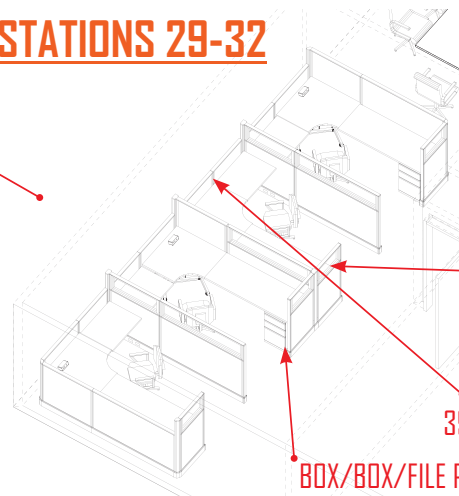

53"H FABRIC/GLASS PANEL
 39"H FABRIC
 14"H GLASS

39"H FABRIC PANEL

BOX/BOX/FILE PEDESTAL

U-SHAPED DESK W/
 MAIN DESK HEIGHT ADJUSTABLE

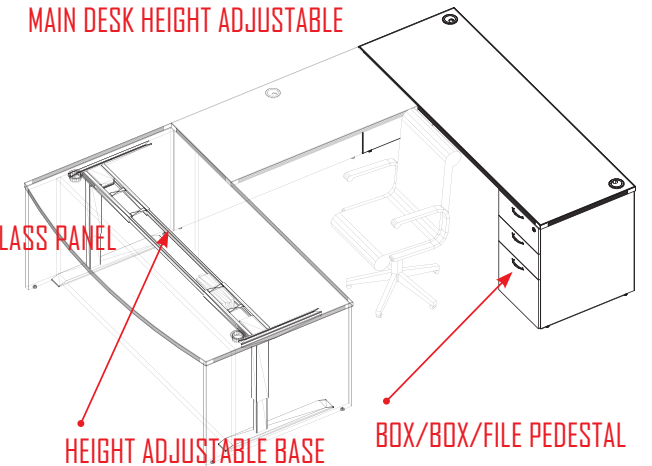

HEIGHT ADJUSTABLE BASE

BOX/BOX/FILE PEDESTAL

3D RENDERS

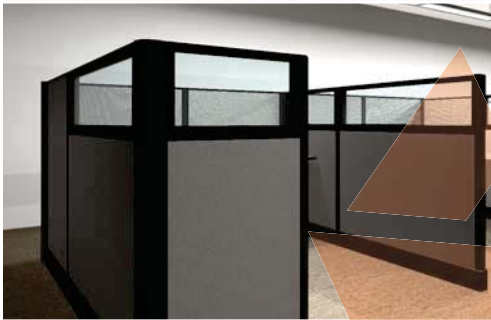

SPD Corporate Office Furniture

Fabric Panels- Bailey
2299-Platinum 7013
Laminate-Shadow Ridge
Paint: Black BU

OFFICE SUITES
PSO



SLATE GRAY LAMINATE

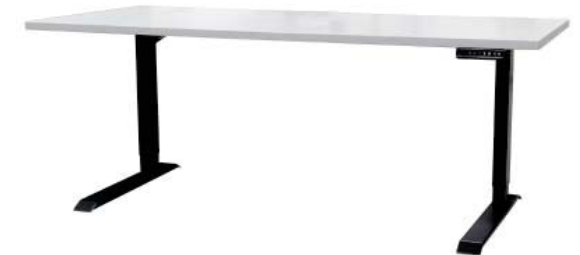

6



Slate Grey

QUALITY - CONFERENCE TABLE
SUPPLY CHAIN OFFICE - CONFERENCE TABLE
BLG COLLECTION // LAMINATE: ASIAN NIGHT

[2] 8'x4' CONFERENCE TABLE W
 [1] POWER BOX / EA



QUALITY OFFICE

SUPPLY CHAIN OFFICE

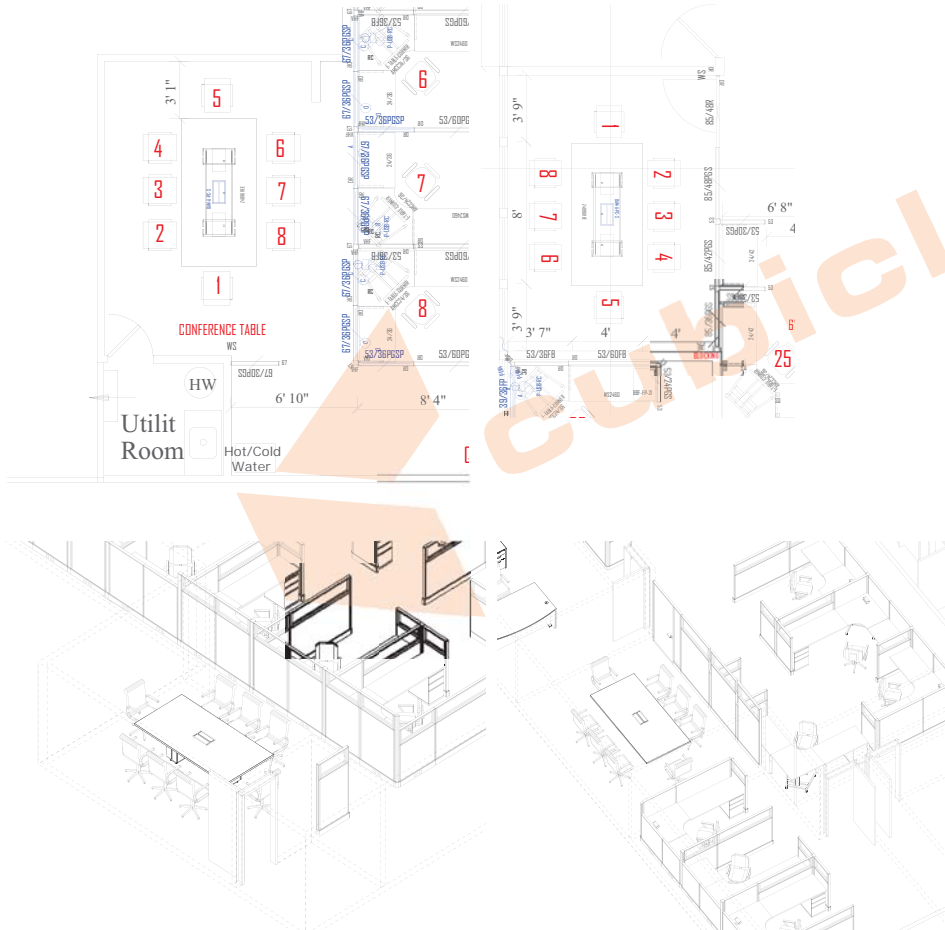

CONFERENCE SEATING - QTY [20] GTO - High Back Luxhide Tilter

23.5" w x 24.5" d x 40" h

Seat Height: 17.5" - 21.5"
Seat Width: 21"
Seat Depth: 17.5"
Back Height: 21"
Back Width: 20"
Arm Height: 7.5"



Ergonomics



Tension Adjustment



Chair Tilt Lock



Seat Height



Waterfall Seat Edge



Contoured Cushions



Center-Tilt Movement

ENGINEERING OFFICE - MEETING TABLE
[4] CONFERENCE CHAIRS
SUPPLY CHAIN OFFICE
[8] CONFERENCE CHAIRS
MARKETING OFFICE
[8] CONFERENCE CHAIRS

CUBICLES.COM is a nationwide leader in the world of office furniture and furniture services. We've spent the last 20+ years building and maintaining a vast network of manufacturers, designers, contractors and facilities allowing us to cater to the commercial office, the home office, and everything in between.

CONTRACT OFFICE FURNISHINGS

Our full-service agency provides a dedicated hands-on team of professional designers, specifiers and project managers to deliver your commercial office project from a conceptual dream to a "ready to move in" reality. We are committed to providing every client with quality products, fair pricing, and efficient service.

PRODUCTS INCLUDE:

Cubicles * Desks * Tables * Reception * Conference * Seating
Filing & Storage * Lounge * Breakroom * Sit Stand * Acoustic Tiles
Modular Walls * Glass Walls * Office Carpeting * Home Living
And more!

SERVICES INCLUDE:

Sales & Rentals (New & Used) * Space Planning & Design
Budgeting & Financing * Project Management * Installation &
Logistics * Moving & Warehousing * Inventory Management

WE PROUDLY SERVE:

Corporate * Residential * Government/GSA * Healthcare * Education



WE SERVE ALL AGENCIES, ALL ACROSS AMERICA

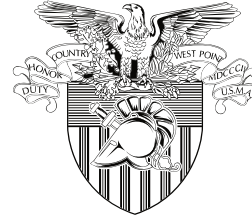

Honeywell



 **Nestlé PURINA**



Collins Aerospace



ONE 70



SIEMENS



REFERENCES AVAILABLE UPON REQUEST



see more at cubicles.com/reviews