

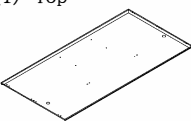

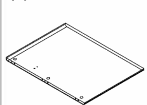



(1) Top  1PCS	(2) End Panel  2PCS	(3) Modesty Panel  1PCS	(A) Dowel  14PCS+1	(B) Cam Pin  12PCS+1	(C) Cam Lock  12PCS+1	(p) Cam Cover  12PCS+1	(D) Leg leveller  4PCS	(W) Grommet  2PCS
--	---	---	--	--	--	---	--	--

STEP 1

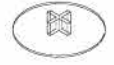

STEP 2

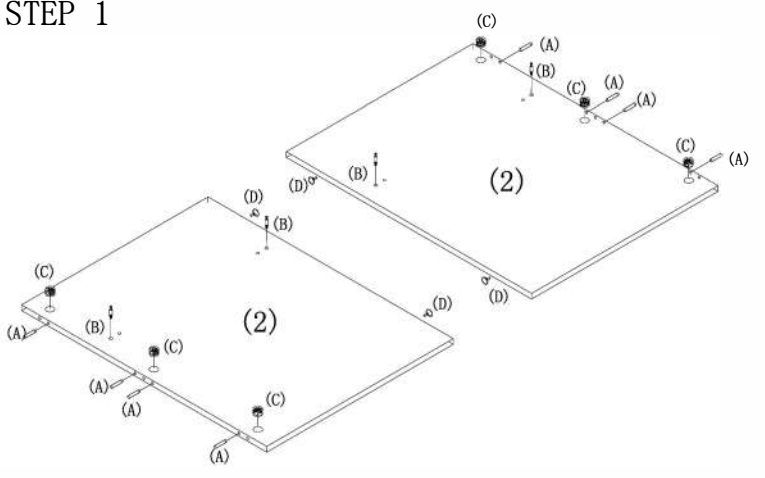
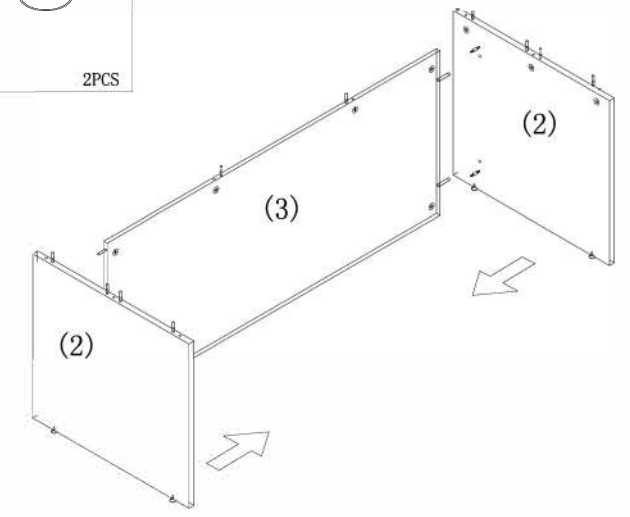
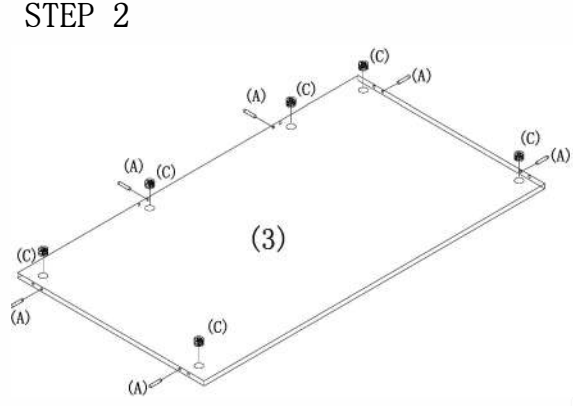

STEP 4

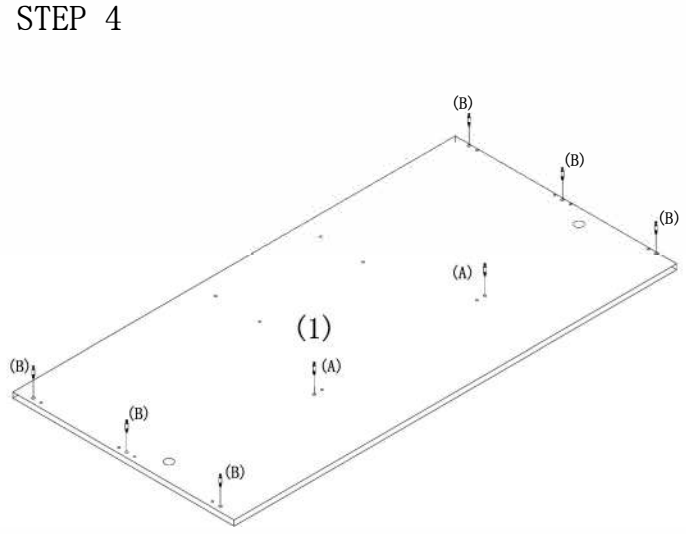

STEP 5

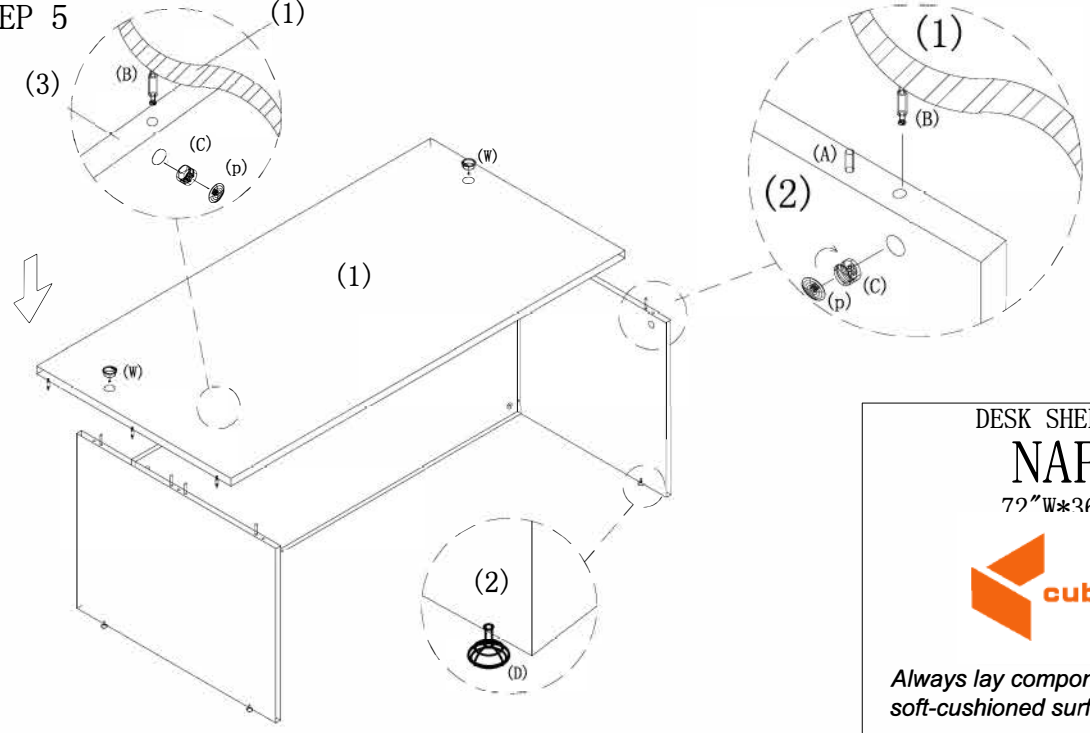

DESK SHELL, 72x36  
**NAP-01**  
 72"W\*36"D\*29"H



*Always lay components on A clean, soft-cushioned surface during assembly.*